



RADIO TEST REPORT

ETSI EN 300 328 V2.1.1 (2016-11)

Product: Bluetooth module

Trade Name:  **cubeacon**

Model Name: CBAR-25

Serial Model: CBAR-25

Report No.: BCTC-LH170803349-3E

Prepared for

PT. Eyro Digital Teknologi

Jl. Amir Mahmud IX/23 Gunung Anyar. Surabaya 60294. Indonesia.

Prepared by

Shenzhen BCTC Testing Co., Ltd.

BCTC Building & 1-2F, East of B Building, Pengzhou Industrial, Fuyuan

1st Road, Qiaotou Community, Fuyong Street, Bao'an

District, Shenzhen, China

Tel: 400-788-9558, 0755-33019988

Web: www.bctc-lab.com.cn



TEST RESULT CERTIFICATION

Applicant's name.....: **PT. Eyro Digital Teknologi**
 Address: Jl. Amir Mahmud IX/23 Gunung Anyar. Surabaya 60294. Indonesia.
Manufacture's Name: **PT. Eyro Digital Teknologi**
 Address: 6th Floor, H Building, Gangzhilong Science Park, Qinglong Road,
 Longhua District, Shenzhen, China

Product description

Product name: Bluetooth module

Trademark: 

Model and/or type reference: CBAR-25

Serial Model: CBAR-25

Standards.....: ETSI EN 300 328 V2.1.1 (2016-11)

This device described above has been tested by BCTC, and the test results show that the equipment under test (EUT) is in compliance with the 2014/53/EU Radio Equipment Directive (RED) Art.3.2 requirements. And it is applicable only to the tested sample identified in the report.

This report shall not be reproduced except in full, without the written approval of BCTC, this document may be altered or revised by BCTC, personal only, and shall be noted in the revision of the document.

Date of Test.....:

Date (s) of performance of tests.....: Sep. 28 - Oct. 13, 2017

Date of Issue.....: Oct. 13, 2017

Test Result.....: **Pass**

Prepared by(Engineer): Eric Yang

Reviewer(Supervisor): Jade Yang

Approved(Manager): Carson Zhang



This test report is based on a single evaluation of one sample of above mentioned products. It is not permitted to be duplicated in extracts without written approval of Shenzhen BCTC Testing Co., Ltd.



TABLE OF CONTENT	Page
1. General Information	4
1.1. Description of Device (EUT)	4
1.2. Accessories of device (EUT)	7
2. Summary of test	8
2.1. Test Standard description:.....	8
2.2. Summary of test result.....	8
2.3. Block Diagram of Configuration for test	8
2.4. Test mode	9
2.5. Test Conditions	9
2.6. Measurement Uncertainty (95% confidence levels, k=2)	9
2.7. Test Equipment	10
3. RF output power.....	12
3.1. Limit	12
3.2. Test Setup.....	12
3.3. Test Procedure	12
3.4. Test Result.....	13
4. Power Spectral Density	16
4.1. Limit	16
4.2. Test Setup.....	16
4.3. Test Procedure	16
4.4. Test Result.....	16
5. Occupied Channel Bandwidth.....	18
5.1. Limit	18
5.2. Test Setup.....	18
5.3. Test Procedure	18
5.4. Test Result.....	18
6. Transmitter unwanted emissions in the out-of-band domain	20
6.1. Limit	20
6.2. Test Setup.....	20
6.3. Test Procedure	21
6.4. Test Result.....	21
7. Transmitter unwanted emissions in the spurious domain	23
7.1. Limit	23
7.2. Test Procedure	23
7.3. Test Result.....	24
8. Receiver Spurious emissions	25
8.1 Limit.....	25
8.2 Test Procedure	25
8.3 Test Result	25
9. Receiver Blocking	26
9.1 Limit.....	26
9.2 Test Setup	27
9.3 Test Procedure	27
9.4 Test Result	28
10. Photos of test setup.....	29
11. Photos of the EUT	30



1. General Information

1.1. Description of Device (EUT)

Equipment	Bluetooth module
Brand Name	
Model Name.	CBAR-25
Serial Model	CBAR-25
Model Difference	All the model are the same circuit and RF module, except model names.
Product Description	Operation Frequency: 2402~2480MHz
	Modulation Type: GFSK
	Number Of Channel: 40CH
	Bit Rate of Transmitter: 2Mbps
	Antenna Designation: PCB Antenna
	Antenna Gain(Peak): 2dBi
	Based on the application, features, or specification exhibited in User's Manual, the EUT is considered as an ITE/Computing Device. More details of EUT technical specification, please refer to the User's Manual.
Channel List	Refer to below
Power Rating	DC3V
Hardware Version	HV1.0
Software Version	SV1.0
Firmware Version	FV01

Note:

1. For a more detailed features description, please refer to the manufacturer's specifications or the User's Manual.

a) The type of modulation used by the equipment:

- FHSS
- other forms of modulation

b) In case of FHSS modulation:

- In case of non-Adaptive Frequency Hopping equipment:
The number of Hopping Frequencies:
- In case of Adaptive Frequency Hopping Equipment:
The maximum number of Hopping Frequencies:
The minimum number of Hopping Frequencies:
The Dwell Time:
The Minimum Channel Occupation Time:

c) Adaptive / non-adaptive equipment:

- non-adaptive Equipment
- adaptive Equipment without the possibility to switch to a non-adaptive mode
- adaptive Equipment which can also operate in a non-adaptive mode



d) In case of adaptive equipment:

The Channel Occupancy Time implemented by the equipment:

- The equipment has implemented an LBT based DAA mechanism
 - In case of equipment using modulation different from FHSS:
 - The equipment is Frame Based equipment
 - The equipment is Load Based equipment
 - The equipment can switch dynamically between Frame Based and Load Based equipment
- The CCA time implemented by the equipment: μ s
- The value q as referred to in clause 4.3.2.5.2.2.2
- The equipment has implemented an non-LBT based DAA mechanism
- The equipment can operate in more than one adaptive mode

e) In case of non-adaptive Equipment:

The maximum RF Output Power (e.i.r.p.): 3.64dBm

The maximum (corresponding) Duty Cycle: %

Equipment with dynamic behaviour, that behaviour is described here. (e.g. the different combinations of duty cycle and corresponding power levels to be declared):

f) The worst case operational mode for each of the following tests:

- RF Output Power
 - GFSK
- Power Spectral Density
 - GFSK
 - Duty cycle, Tx-Sequence, Tx-gap
- Dwell time, Minimum Frequency Occupation & Hopping Sequence (only for FHSS equipment)
- Hopping Frequency Separation (only for FHSS equipment)
- Medium Utilisation

.....
- Adaptivity & Receiver Blocking

.....
- Occupied Channel Bandwidth
 - GFSK
- Transmitter unwanted emissions in the OOB domain
 - GFSK
- Transmitter unwanted emissions in the spurious domain
 - GFSK
- Receiver spurious emissions
 - GFSK

g) The different transmit operating modes (tick all that apply):

- Operating mode 1: Single Antenna Equipment
 - Equipment with only 1 antenna
 - Equipment with 2 diversity antennas but only 1 antenna active at any moment in time
 - Smart Antenna Systems with 2 or more antennas, but operating in a (legacy) mode where only 1 antenna is used. (e.g. IEEE 802.11™ [i.3] legacy mode in smart antenna systems)
 - Operating mode 2: Smart Antenna Systems - Multiple Antennas without beam forming
 - Single spatial stream / Standard throughput / (e.g. IEEE 802.11™ [i.3] legacy mode)
 - High Throughput (> 1 spatial stream) using Occupied Channel Bandwidth 1
 - High Throughput (> 1 spatial stream) using Occupied Channel Bandwidth 2
- NOTE: Add more lines if more channel bandwidths are supported.
- Operating mode 3: Smart Antenna Systems - Multiple Antennas with beam forming
 - Single spatial stream / Standard throughput (e.g. IEEE 802.11™ [i.3] legacy mode)
 - High Throughput (> 1 spatial stream) using Occupied Channel Bandwidth 1
 - High Throughput (> 1 spatial stream) using Occupied Channel Bandwidth 2



NOTE: Add more lines if more channel bandwidths are supported.

h) In case of Smart Antenna Systems:

- The number of Receive chains:
- The number of Transmit chains:
- symmetrical power distribution
- asymmetrical power distribution

In case of beam forming, the maximum beam forming gain:

NOTE: Beam forming gain does not include the basic gain of a single antenna.

i) Operating Frequency Range(s) of the equipment:

- Operating Frequency Range 1: 2402 MHz to 2480 MHz
- Operating Frequency Range 2: MHz to MHz

NOTE: Add more lines if more Frequency Ranges are supported.

j) Occupied Channel Bandwidth(s):

Occupied Channel Bandwidth 1: 1.124MHz

Occupied Channel Bandwidth 2:

NOTE: Add more lines if more channel bandwidths are supported.

k) Type of Equipment (stand-alone, combined, plug-in radio device, etc.):

- Stand-alone
- Combined Equipment (Equipment where the radio part is fully integrated within another type of equipment)
- Plug-in radio device (Equipment intended for a variety of host systems)
- Other

l) The extreme operating conditions that apply to the equipment:

Operating temperature range:-10° C to 40° C

Operating voltage range: 2.7V to 3.6V AC DC

- Details provided are for the:
- stand-alone equipment
 - combined (or host) equipment
 - test jig

m) The intended combination(s) of the radio equipment power settings and one or more antenna assemblies and their corresponding e.i.r.p levels:

- Antenna Type
 - Integral Antenna
 - Antenna Gain: 2 dBi
 - If applicable, additional beamforming gain (excluding basic antenna gain): dB
 - Temporary RF connector provided
 - No temporary RF connector provided
 - Dedicated Antennas (equipment with antenna connector)
 - Single power level with corresponding antenna(s)
 - Multiple power settings and corresponding antenna(s)
 - Number of different Power Levels:
 - Power Level 1: dBm
 - Power Level 2: dBm
 - Power Level 3: dBm

NOTE 1: Add more lines in case the equipment has more power levels.

NOTE 2: These power levels are conducted power levels (at antenna connector).

n) The nominal voltages of the stand-alone radio equipment or the nominal voltages of the combined (host) equipment or test jig in case of plug-in devices:

- Details provided are for the:
- stand-alone equipment
 - combined (or host) equipment
 - test jig



Supply Voltage AC mains State AC voltage V
 DC State DC voltage :3V

In case of DC, indicate the type of power source

- Internal Power Supply
- External Power Supply or AC/DC adapter
- Battery:
- Other:

o) Describe the test modes available which can facilitate testing:

The EUT can be into the Engineer mode for testing.

p) The equipment type (e.g. Bluetooth®, IEEE 802.11™ [i.3], proprietary, etc.):

Bluetooth

1.2. Accessories of device (EUT)

Item	Equipment	Mfr/Brand	Model/Type No.	Series No.	Note
E1	Bluetooth module		CBAR-25	N/A	EUT

Item	Shielded Type	Ferrite Core	Length	Note



2. Summary of test

2.1. Test Standard description:

ETSI EN 300 328 V2.1.1: Electromagnetic compatibility and Radio spectrum Matters (ERM); Wideband transmission systems; Data transmission equipment operating in the 2,4 GHz ISM band and using wide band modulation techniques; Harmonized EN covering the essential requirements of article 3.2 of the R&ED Directive

2.2. Summary of test result

Transmitter Parameters			
No	Test	Clause No	Result
1	RF Output Power	4.3.2.2	PASS
2	Power Spectral Density	4.3.2.3	PASS
3	Duty Cycle, Tx-sequence, Tx-gap	4.3.2.4	N/A
4	Medium Utilisation (MU) factor	4.3.2.5	N/A
5	Adaptivity	4.3.2.6	N/A
6	Occupied Channel Bandwidth	4.3.2.7	PASS
7	Transmitter unwanted emissions in the OOB domain	4.3.2.8	PASS
8	Transmitter unwanted emissions in the spurious domain	4.3.2.9	PASS
Receiver Parameters			
9	Receiver spurious emissions	4.3.2.10	PASS
10	Receiver Blocking	4.3.2.11	PASS
11	Geo-location capability	4.3.2.12	N/A

Note: N/A is an abbreviation for Not Applicable and means this test item is not applicable for this device according to the technology characteristic of device.

2.3. Block Diagram of Configuration for test

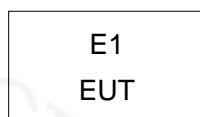



2.4. Test mode

The special RF test software was used to control EUT work in Continuous Bluetooth TX mode, and select test channel, wireless mode.

Mode	data rate (Mbps)	Channel	Frequency (MHz)
GFSK	2	Low :CH1	2402
	2	Middle: CH20	2440
	2	High: CH40	2480

2.5. Test Conditions

	Normal Conditions	Extreme Conditions
Temperature range	10-40°C	-10°C and 40°C
Humidity range	20-75%	20-75%
Pressure range	86-106kPa	86-106kPa
Power supply	DC3V	2.7V and 3.3V (declared by the manufacturer.)
Note 1: The test procedure described in clause 5.1.1 of EN300 328 was used for extreme test procedure. 2: The Extreme Temperature and Extreme Voltages declared by the manufacturer.		

2.6. Measurement Uncertainty (95% confidence levels, k=2)

Item	MU	Remark
Uncertainty for Conducted Emission Test	2.50dB	
Uncertainty for Radiation Emission test in 3m chamber (30MHz to 1GHz)	3.04 dB	Polarize: V
	3.02dB	Polarize: H
Uncertainty for Radiation Emission test in 3m chamber (1GHz to 25GHz)	3.56dB	Polarize: H
	3.84dB	Polarize: V
Uncertainty for radio frequency	1×10^{-9}	
Uncertainty for conducted RF Power	0.65dB	
Uncertainty for temperature	0.6°C	
Uncertainty for humidity	1%	



2.7. Test Equipment

Item	Equipment	Manufacture	Model No.	Serial No.	Cal.Date (mm-dd-yy)	Cal.Due date (mm-dd-yy)
1	3m Semi-Anechoic	ETS-LINDGREN	N/A	SEL0017	2017.08.15	2018.08.14
2	Spectrum analyzer	Agilent	E4407B	MY46185649	2017.08.15	2018.08.14
3	Receiver	R&S	ESCI	1166.5950K03- 1011	2017.08.15	2018.08.14
4	Receiver	R&S	ESCI	101202	2017.08.15	2018.08.14
5	Bilog Antenna	Schwarzbeck	VULB 9168	VULB9168-438	2017.08.15	2018.08.14
6	Horn Antenna	EMCO	3115	640201028-06	2017.08.15	2018.08.14
7	Power Meter	Anritsu	ML2495A	1204003	2017.08.15	2018.08.14
8	Power Sensor	Anritsu	MA2411B	100309	2017.08.15	2018.08.14
9	Active Loop Antenna	Beijing Daze	ZN30900A	SEL0097	2017.08.15	2018.08.14
10	Cable	Resenberger	N/A	No.1	2017.08.15	2018.08.14
11	Cable	SCHWARZBECK	N/A	No.2	2017.08.15	2018.08.14
12	Cable	SCHWARZBECK	N/A	No.3	2017.08.15	2018.08.14
13	Pre-amplifier	Schwarzbeck	BBV9743	9743-019	2017.08.15	2018.08.14
14	Pre-amplifier	R&S	AFS33-18002650-30- 8P-44	SEL0080	2017.08.15	2018.08.14
15	Base station	Agilent	E5515C	GB44300243	2017.08.15	2018.08.14
16	Temperature controller	Terchy	MHQ	120	2017.08.15	2018.08.14
17	Power divider	Anritsu	K240C	020346	2017.08.15	2018.08.14
18	Signal Generator	HP	83732B	VS3449051	2017.08.15	2018.08.14



19	Attenuator	Agilent	8491B	MY39262165	2017.08.15	2018.08.14
20	vector Signal Generator	Agilent	E4438C	MY49070163	2017.08.15	2018.08.14
21	splitter	Mini-Circuits	ZAP-50W	NN256400424	2017.08.15	2018.08.14
22	Directional Coupler	Agilent	87300C	MY44300299	2017.08.15	2018.08.14
23	vector Signal Generator	Agilent	E4438C	US44271917	2017.08.15	2018.08.14
24	X-series USB Peak and Average Power Sensor	Agilent	U2021XA	MY54080020	2017.08.15	2018.08.14
25	X-series USB Peak and Average Power Sensor	Agilent	U2021XA	MY54110001	2017.08.15	2018.08.14
26	X-series USB Peak and Average Power Sensor	Agilent	U2021XA	MY53480008	2017.08.15	2018.08.14
27	X-series USB Peak and Average Power Sensor	Agilent	U2021XA	MY54080019	2017.08.15	2018.08.14
28	4 Ch.Simultaneous Sampling 14 Bits 2 MS/s	Agilent	U2531A	TW54063507	2017.08.15	2018.08.14
29	4 Ch.Simultaneous Sampling 14 Bits 2 MS/s	Agilent	U2531A	TW54063513	2017.08.15	2018.08.14
30	splitter	Mini	PS3-7	4463	2017.08.15	2018.08.14
31	Signal Analyzer	Agilent	N9010A	MY48030494	2017.08.15	2018.08.14

3. RF output power

3.1. Limit

For adaptive equipment using wide band modulations other than FHSS, the maximum RF output power shall be 20 dBm.

The maximum RF output power for non-adaptive equipment shall be declared by the supplier and shall not exceed 20 dBm. See clause 5.4.1 m). For non-adaptive equipment using wide band modulations other than FHSS, the maximum RF output power shall be equal to or less than the value declared by the supplier.

This limit shall apply for any combination of power level and intended antenna assembly.

Limit
20dBm

3.2. Test Setup

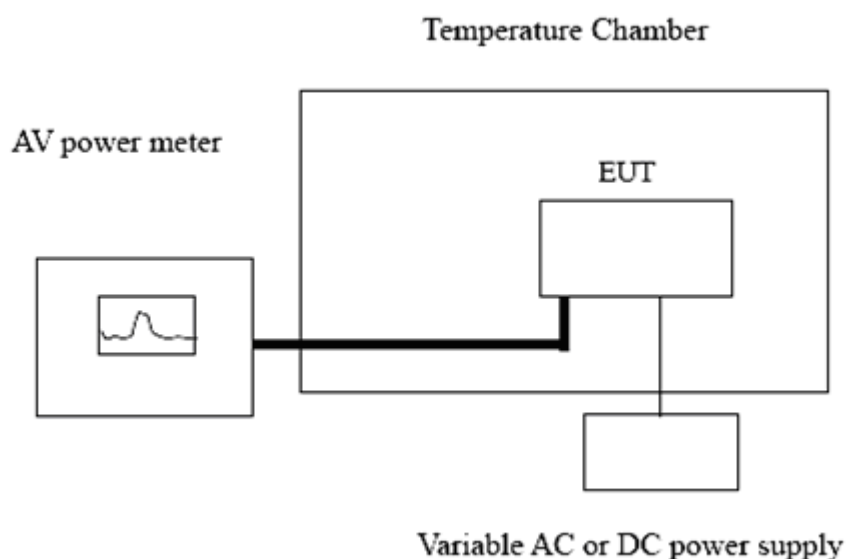

3.3. Test Procedure

Refer to ETSI EN 300 328 V2.1.1 (2016-11) Clause 5.4.2.2



3.4. Test Result

EUT: Bluetooth module				
Cable loss: 0.6dB		Attenuator loss: 20dB		Antenna Gain: 0dBi
Mode	Condition	Channel	Result	Limit
			Total e.i.r.p (dBm)	e.i.r.p (dBm)
GFSK	Normal 25°C/3V	Lowest	2.65	20
		Middle	3.64	20
		Highest	3.28	20
	-10°C/2.7V	Lowest	2.96	20
		Middle	3.12	20
		Highest	3.01	20
	-10°C/3.3V	Lowest	2.98	20
		Middle	3.03	20
		Highest	2.96	20
	40°C/2.7V	Lowest	3.05	20
		Middle	2.78	20
		Highest	3.16	20
	40°C/3.3V	Lowest	2.81	20
		Middle	3.06	20
		Highest	2.98	20
Conclusion: PASS				



The test plot of normal condition is below:

Channel	Voltage	Burst RMS power (dBm)
GFSK CH Low-2402	Normal	2.65

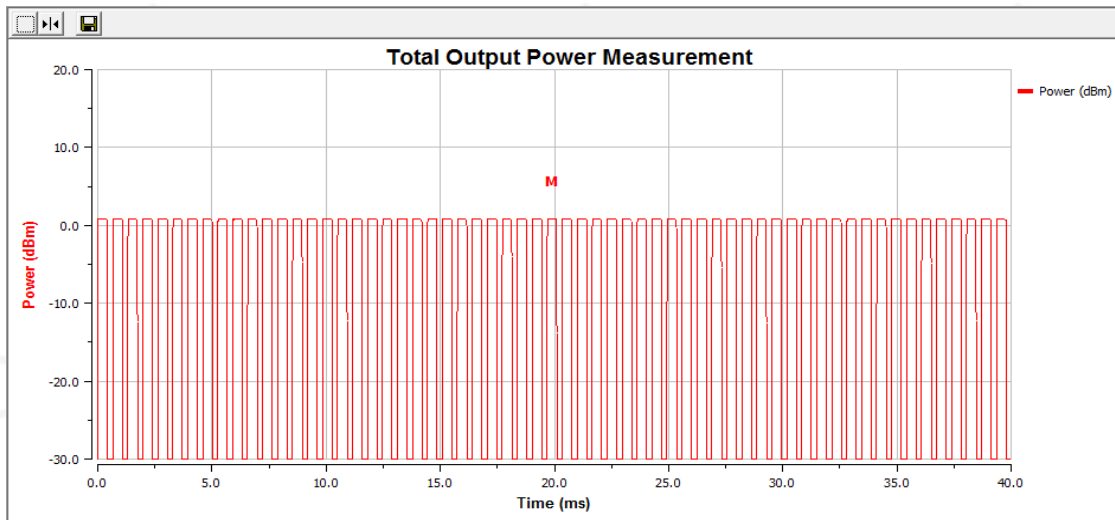

Channel	Voltage	Burst RMS power (dBm)
GFSK CH Mid-2440	Normal	3.64

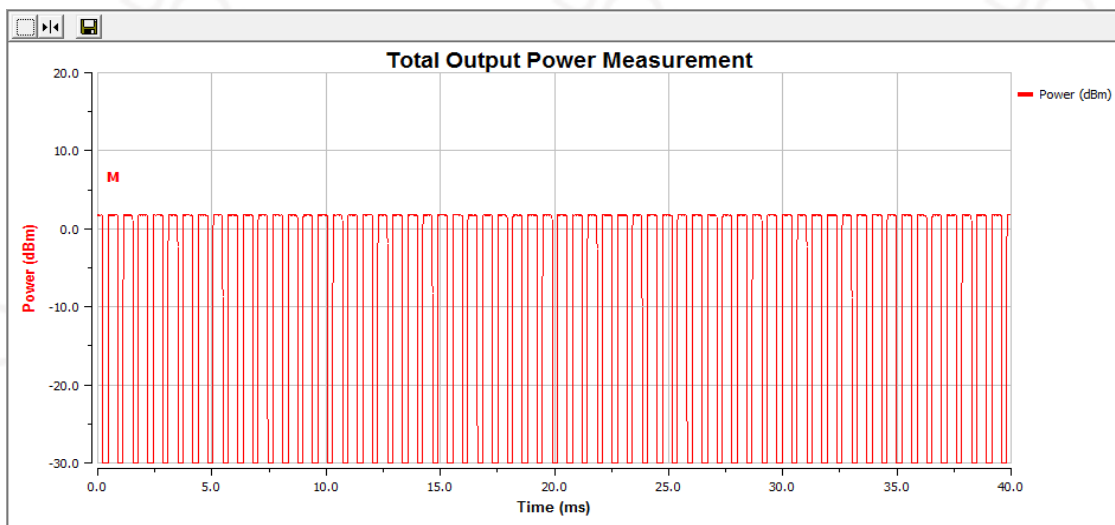



Channel	Voltage	Burst RMS power (dBm)
GFSK CH High-2480	Normal	3.28

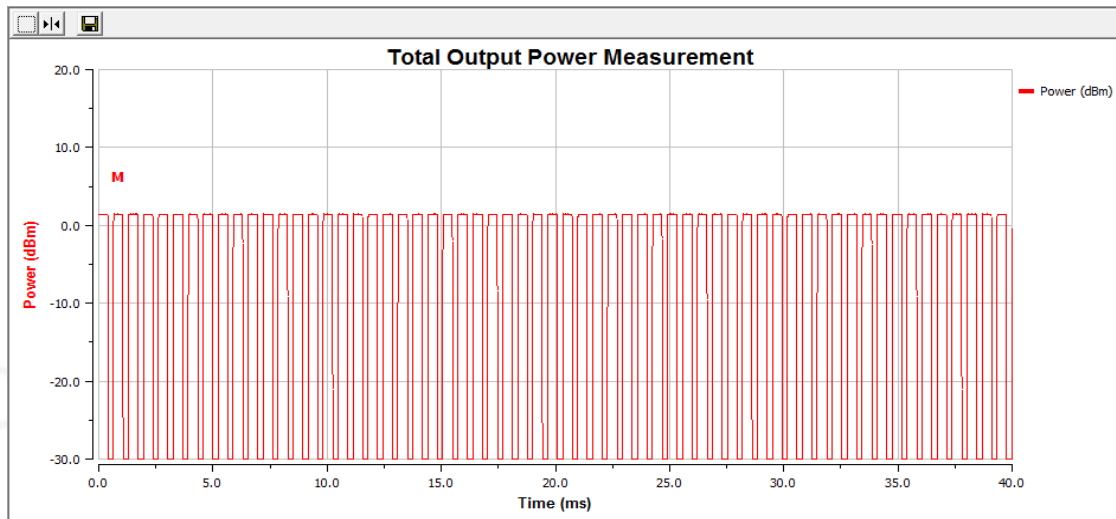

4. Power Spectral Density

4.1. Limit

10dBm/MHz

4.2. Test Setup

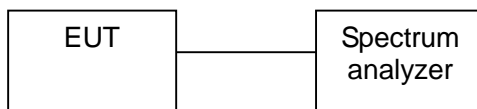

4.3. Test Procedure

Refer to ETSI EN 300 328 V2.1.1 (2016-11) Clause 5.4.3.2

4.4. Test Result

Bluetooth mode			
Channel	Power Spectral Density (dBm/MHz)	Limit (dBm/MHz)	Result
Lowest	2.57	10.00	Pass
Middle	3.54		
Highest	3.20		

Test plots are below:

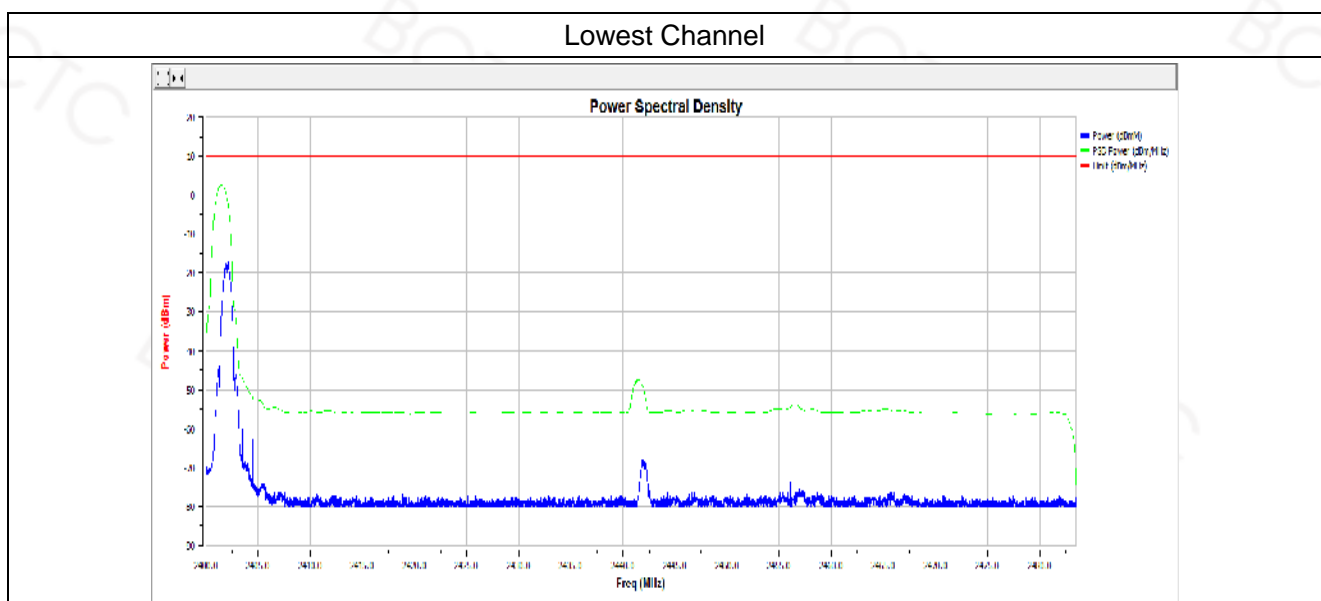



Middle Channel

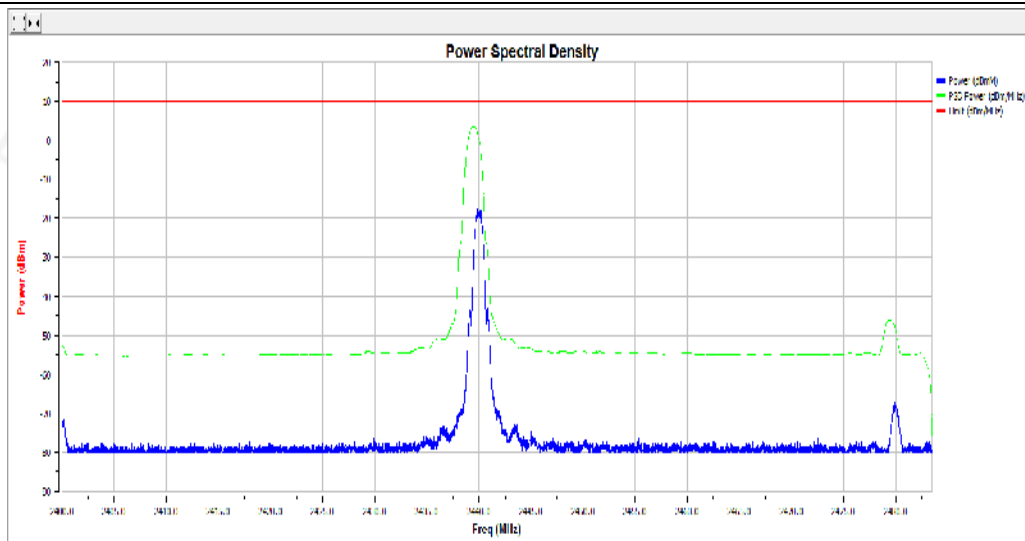

Highest Channel

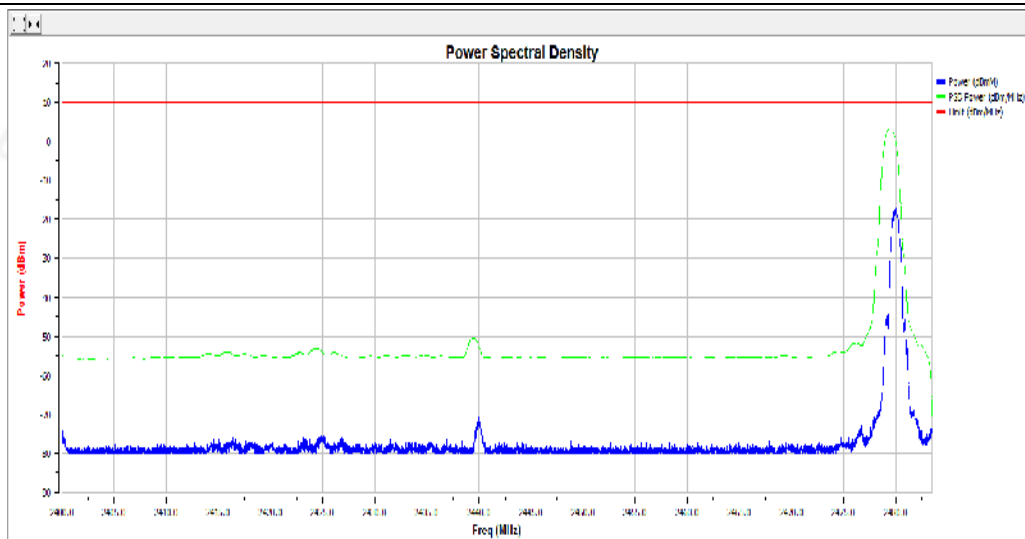

5. Occupied Channel Bandwidth

5.1. Limit

The Occupied Channel Bandwidth shall fall completely within the band given in 2.4GHz to 2.4835GHz.

In addition, for non-adaptive systems using wide band modulations other than FHSS and with e.i.r.p greater than 10 dBm, the occupied channel bandwidth shall be less than 20 MHz.

5.2. Test Setup



5.3. Test Procedure

Refer to ETSI EN 300 328 V2.1.1 (2016-11) Clause 5.4.7.2

5.4. Test Result

Test conditions	Bluetooth mode					
	Test Channel	99% Bandwidth (MHz)	Declared Bandwidth (MHz)	F _L /F _H (MHz)	Limit	Result
Normal 25°C/3V	Lowest	1.083	1.2	2401.455	2400MHz ~ 2483.5MHz	Pass
	Highest	1.099	1.2	2480.545		Pass
-10°C/2.7V	Lowest	1.085	1.2	2401.362		Pass
	Highest	1.063	1.2	2480.235		Pass
-10°C/3.3V	Lowest	1.058	1.2	2401.321		Pass
	Highest	1.068	1.2	2480.324		Pass
40°C/2.7V	Lowest	1.095	1.2	2401.362		Pass
	Highest	1.042	1.2	2480.312		Pass
40°C/3.3V	Lowest	1.058	1.2	2401.985		Pass
	Highest	1.069	1.2	2480.489		Pass



Test plots are below:

Normal

CH Low

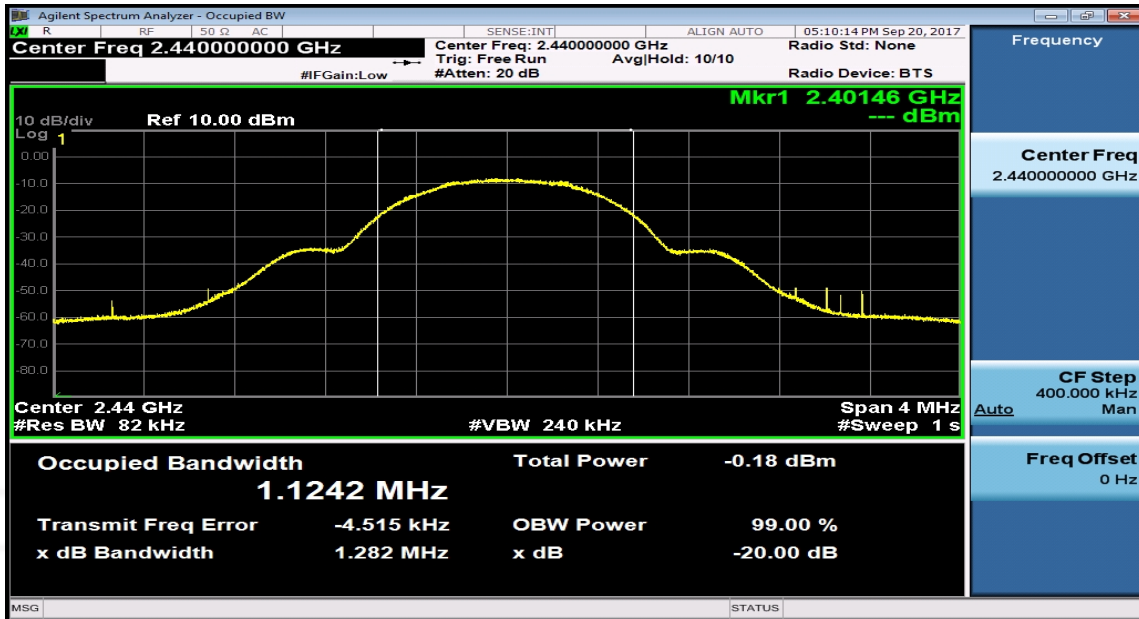

CH High

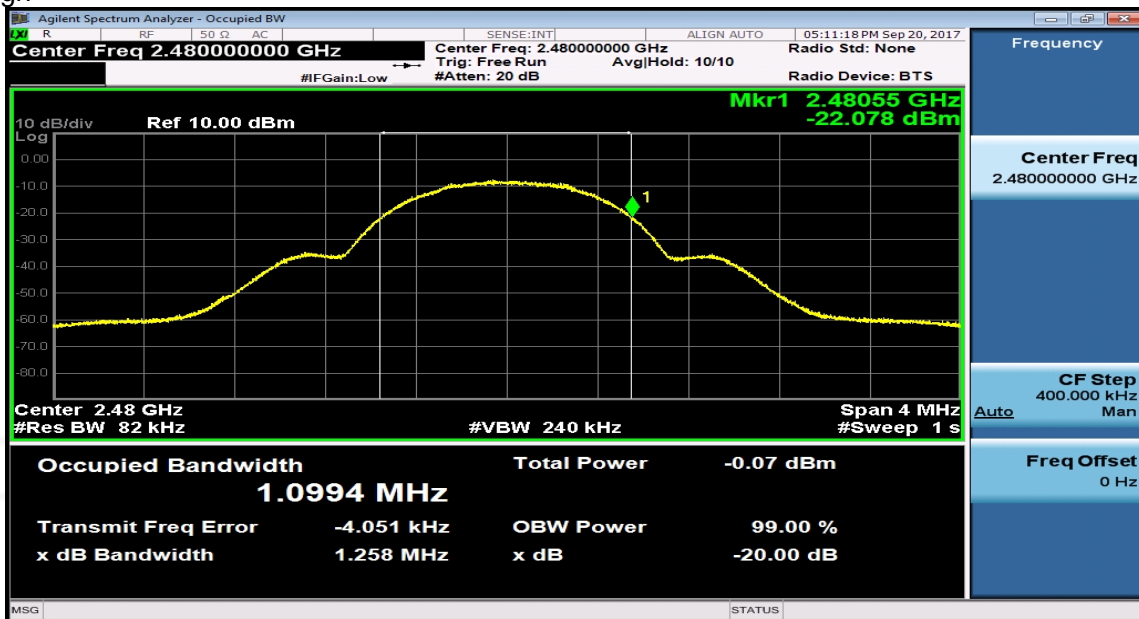

6. Transmitter unwanted emissions in the out-of-band domain

6.1. Limit

The transmitter unwanted emissions in the out-of-band domain but outside the allocated band, shall not exceed the values provided by the mask in figure 3.

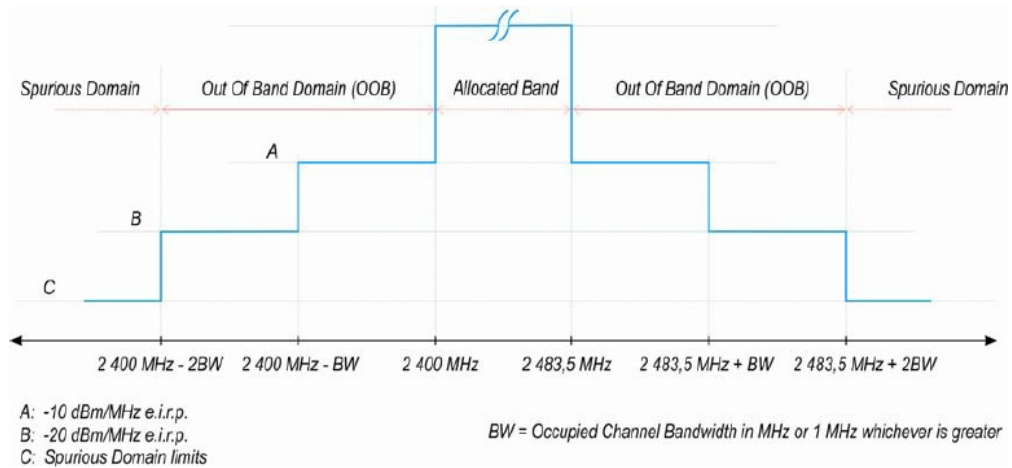
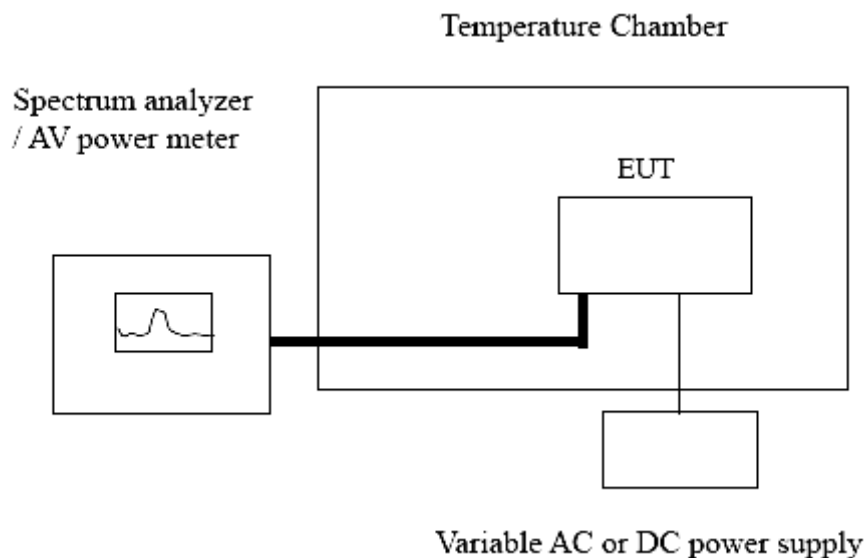

Figure 3: Transmit mask

6.2. Test Setup



6.3. Test Procedure

Refer to ETSI EN 300 328 V2.1.1 (2016-11) Clause 5.4.8.2

Connect the UUT to the spectrum analyzer and use the following settings:

RBW/ VBW	1MHz/3MHz
Span	0Hz
Filter mode	Channel filter
Sweep mode	Continuous
Sweep Points	5000
Detector	RMS
Trace mode	Clear / Write
Trigger Mode	Video trigger

6.4. Test Result

GFSK mode:

Test Condition			Lower Band Edge		Higher Band Edge	
Test Mode	Temp	Voltage	Segment A (dBm/MHz)	Segment B (dBm/MHz)	Segment A (dBm/MHz)	Segment B (dBm/MHz)
GFSK	Normal	Normal	-49.85	-56.08	-57.12	-59.31
	40°C	2.7V	-50.4	-56.21	-59.31	-59.4
	40°C	3.3V	-49.96	-56.32	-56.32	-58.96
	-10°C	2.7V	-50.21	-52.96	-55.95	-57.84
	-10°C	3.3V	-49.95	-50.29	-53.91	-58.62
Limit			-10	-20	-10	-20
Conclusion			PASS			
Remark: All modulations of EUT have been tested, but only show the test data of the worst case in this report.						



CH Low (Normal Temp)

Channel	Antenna	Frequency	Level	Limit
CH Low-2402	Antenna 1	2399.5	-49.85	-10
CH Low-2402	Antenna 1	2398.417	-56.08	-20

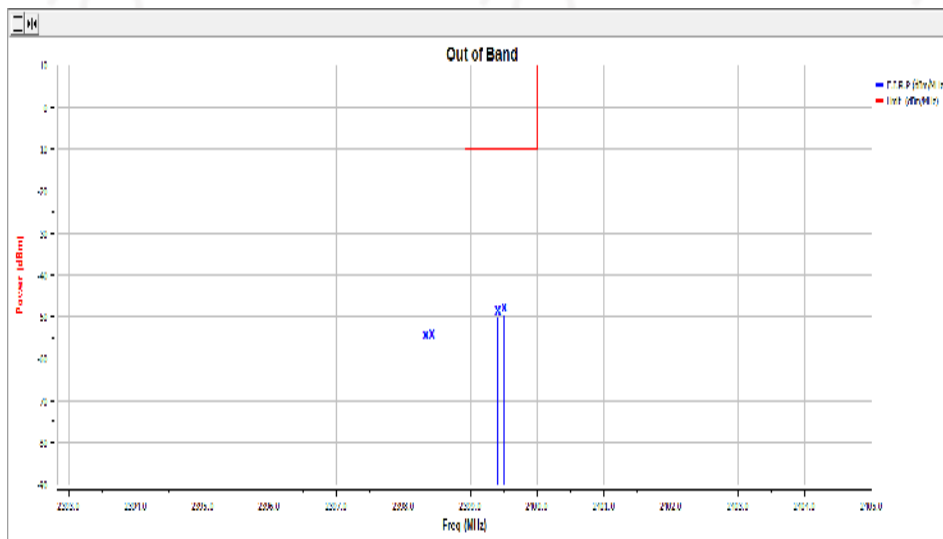

CH High (Normal Temp)

Channel	Antenna	Frequency	Level	Limit
CH Low-2480	Antenna 1	2484	-57.12	-10
CH Low-2480	Antenna 1	2485.099	-59.31	-20

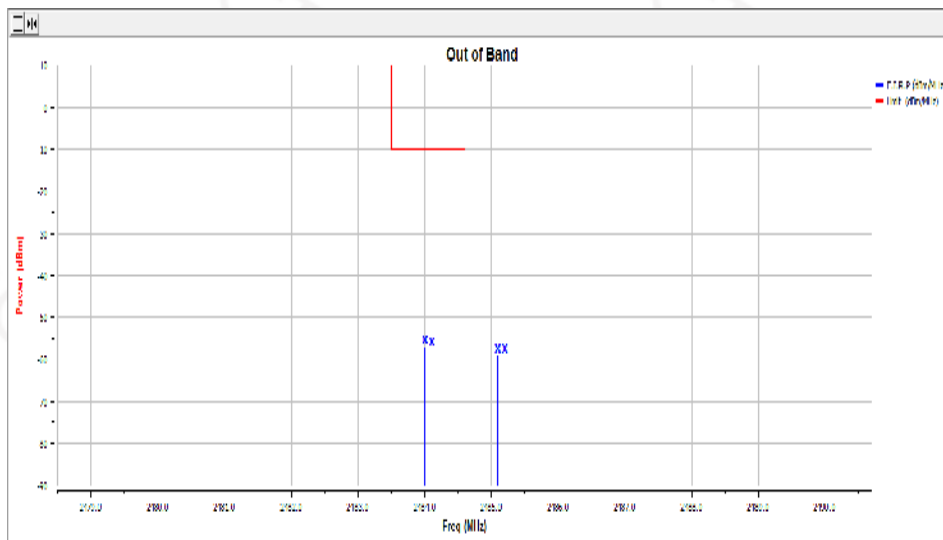

7. Transmitter unwanted emissions in the spurious domain

7.1. Limit

The transmitter unwanted emissions in the spurious domain shall not exceed the values given in table 4.

Table 4: Transmitter limits for spurious emissions

Frequency range	Maximum power, e.r.p. (≤ 1 GHz) e.i.r.p. (> 1 GHz)	Bandwidth
30 MHz to 47 MHz	-36 dBm	100 kHz
47 MHz to 74 MHz	-54 dBm	100 kHz
74 MHz to 87,5 MHz	-36 dBm	100 kHz
87,5 MHz to 118 MHz	-54 dBm	100 kHz
118 MHz to 174 MHz	-36 dBm	100 kHz
174 MHz to 230 MHz	-54 dBm	100 kHz
230 MHz to 470 MHz	-36 dBm	100 kHz
470 MHz to 862 MHz	-54 dBm	100 kHz
862 MHz to 1 GHz	-36 dBm	100 kHz
1 GHz to 12,75 GHz	-30 dBm	1 MHz

7.2. Test Procedure

Refer to ETSI EN 300 328 V2.1.1 (2016-11) Clause 5.4.9.2.2



7.3. Test Result

The lowest channel					
Frequency (MHz)	Spurious Emission		Limit (dBm)	Test Result	
	polarization	Level(dBm)			
75.96	Vertical	-65.91	-54.00	Pass	
94.88	V	-63.14	-54.00		
4804.00	V	-42.74	-30.00		
7206.00	V	-48.54	-30.00		
9608.00	V	-47.83	-30.00		
12010.00	V	-45.18	-30.00		
90.58	Horizontal	-62.98	-54.00		
106.85	H	-66.93	-54.00		
4804.00	H	-42.94	-30.00		
7206.00	H	-45.84	-30.00		
9608.00	H	-46.17	-30.00		
12010.00	H	-44.84	-30.00		
The highest channel					
Frequency (MHz)	Spurious Emission		Limit (dBm)		Test Result
	polarization	Level(dBm)			
225.96	Vertical	-75.91	-54.00	Pass	
545.94	V	-68.54	-54.00		
4804.00	V	-45.96	-30.00		
7206.00	V	-47.14	-30.00		
9608.00	V	-42.96	-30.00		
12010.00	V	-46.92	-30.00		
102.93	Horizontal	-68.47	-54.00		
225.91	H	-64.81	-54.00		
4804.00	H	-49.65	-30.00		
7206.00	H	-48.94	-30.00		
9608.00	H	-41.07	-30.00		
12010.00	H	-49.63	-30.00		

8. Receiver Spurious emissions

8.1 Limit

The spurious emissions of the receiver shall not exceed the values given in table 5.

Table 5: Spurious emission limits for receivers

Frequency Range	Limit
30MHz to 1GHz	-57dBm
1GHz to 12.75GHz	-47dBm

8.2 Test Procedure

Refer to ETSI EN 300 328 V2.1.1 (2016-11) Clause 5.4.10.2

8.3 Test Result

The lowest channel				
Frequency (MHz)	Spurious Emission		Limit (dBm)	Test Result
	polarization	Level(dBm)		
241.39	Vertical	-73.94	2nW/ -57dBm below 1GHz, 20nW/ -47dBm above 1GHz.	Pass
459.15	V	-65.87		
4804.00	V	-63.91		
7206.00	V	-52.48		
9608.00	V	-56.98		
183.14	Horizontal	-72.84		
308.69	H	-65.19		
4804.00	H	-63.94		
7206.00	H	-62.74		
9608.00	H	-54.16		
The highest channel				
Frequency (MHz)	Spurious Emission		Limit (dBm)	Test Result
	polarization	Level(dBm)		
189.61	Vertical	-61.85	2nW/ -57dBm below 1GHz, 20nW/ -47dBm above 1GHz.	Pass
429.67	V	-65.94		
4804.00	V	-66.90		
7206.00	V	-54.17		
9608.00	V	-57.91		
225.91	Horizontal	-73.46		
497.16	H	-66.01		
4804.00	H	-65.98		
7206.00	H	-57.46		
9608.00	H	-58.87		

9. Receiver Blocking

9.1 Limit

While maintaining the minimum performance criteria as defined in clause 4.3.2.11.3, the blocking levels at specified frequency offsets shall be equal to or greater than the limits defined for the applicable receiver category provided in table 14, table 15 or table 16.

Receiver Category 1

Table 14 contains the Receiver Blocking parameters for Receiver Category 1 equipment.

Table 14: Receiver Blocking parameters for Receiver Category 1 equipment

Wanted signal mean power from companion device (dBm)	Blocking signal frequency (MHz)	Blocking signal power (dBm) (see note 2)	Type of blocking signal
$P_{min} + 6$ dB	2 380 2 503,5	-53	CW
$P_{min} + 6$ dB	2 300 2 330 2 360	-47	CW
$P_{min} + 6$ dB	2 523,5 2 553,5 2 583,5 2 613,5 2 643,5 2 673,5	-47	CW
NOTE 1: P_{min} is the minimum level of the wanted signal (in dBm) required to meet the minimum performance criteria as defined in clause 4.3.2.11.3 in the absence of any blocking signal.			
NOTE 2: The levels specified are levels in front of the UUT antenna. In case of conducted measurements, the levels have to be corrected by the actual antenna assembly gain.			

Receiver Category 2

Table 15 contains the Receiver Blocking parameters for Receiver Category 2 equipment.

Table 15: Receiver Blocking parameters receiver category 2 equipment

Wanted signal mean power from companion device (dBm)	Blocking signal frequency (MHz)	Blocking signal power (dBm) (see note 2)	Type of blocking signal
$P_{min} + 6$ dB	2 380 2 503,5	-57	CW
$P_{min} + 6$ dB	2 300 2 583,5	-47	CW
NOTE 1: P_{min} is the minimum level of the wanted signal (in dBm) required to meet the minimum performance criteria as defined in clause 4.3.2.11.3 in the absence of any blocking signal.			
NOTE 2: The levels specified are levels in front of the UUT antenna. In case of conducted measurements, the levels have to be corrected by the actual antenna assembly gain.			

Receiver Category 3

Table 16 contains the Receiver Blocking parameters for Receiver Category 3 equipment.

Table 16: Receiver Blocking parameters receiver category 3 equipment

Wanted signal mean power from companion device (dBm)	Blocking signal frequency (MHz)	Blocking signal power (dBm) (see note 2)	Type of blocking signal
$P_{min} + 12$ dB	2 380 2 503,5	-57	CW
$P_{min} + 12$ dB	2 300 2 583,5	-47	CW

NOTE 1: P_{min} is the minimum level of the wanted signal (in dBm) required to meet the minimum performance criteria as defined in clause 4.3.2.11.3 in the absence of any blocking signal.

NOTE 2: The levels specified are levels in front of the UUT antenna. In case of conducted measurements, the levels have to be corrected by the actual antenna assembly gain.

9.2 Test Setup

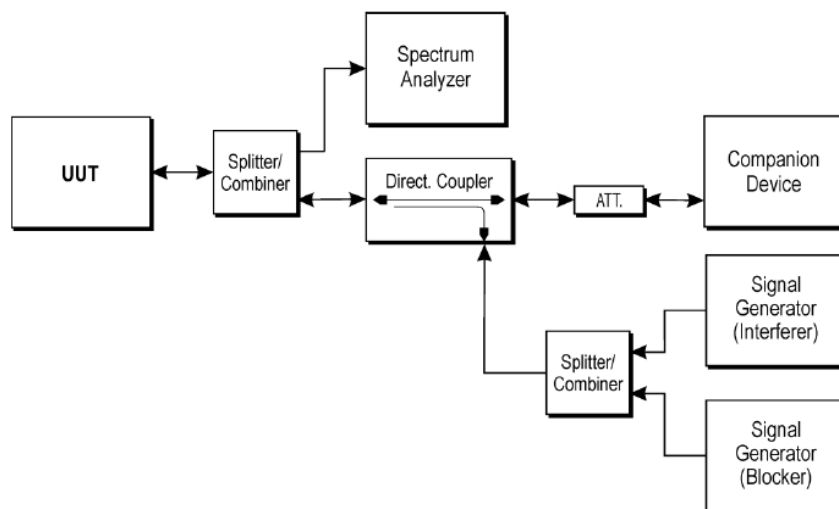

9.3 Test Procedure

Refer to ETSI EN300 328 V2.1.1 (2016-11) Clause 5.4.11.2.



9.4 Test Result

Receiver categories: Receiver Category 3						
Pmin(dBm)	Test Mode	Blocking signal frequency (MHz)	Blocking signal power(dBm) CW	PER	Limit	Results
-54.00	BLE Mode 2402MHz	2380, 2503.5	-57	5.9%	10%	PASS
				3.4%		
		2300 2583.5	-47	4.8%		PASS
				6.8%		
NOTE: (1)The minimum performance criterion shall be a PER less than or equal to 10 %. The manufacturer may declare alternative performance criteria as long as that is appropriate for the intended use of the equipment (see clause 5.4.1.t)). (2) Manufacturer is declared PER, can be used is greater -42dBm. (3)The wanted power 's signal generator send the power to UUT, and make sure EUT's PER is around 10%.						

Receiver categories: Receiver Category 3						
Pmin(dBm)	Test Mode	Blocking signal frequency (MHz)	Blocking signal power(dBm) CW	PER	Limit	Results
-54.00	BLE Mode 2480MHz	2380, 2503.5	-57	4.7%	10%	PASS
				3.1%		
		2300 2583.5	-47	4.3%		PASS
				5.4%		
NOTE: (1)The minimum performance criterion shall be a PER less than or equal to 10 %. The manufacturer may declare alternative performance criteria as long as that is appropriate for the intended use of the equipment (see clause 5.4.1.t)). (2) Manufacturer is declared PER, can be used is greater -42dBm. (3)The wanted power 's signal generator send the power to UUT, and make sure EUT's PER is around 10%.						

10. Photos of test setup



11. Photos of the EUT

EUT Photos 1

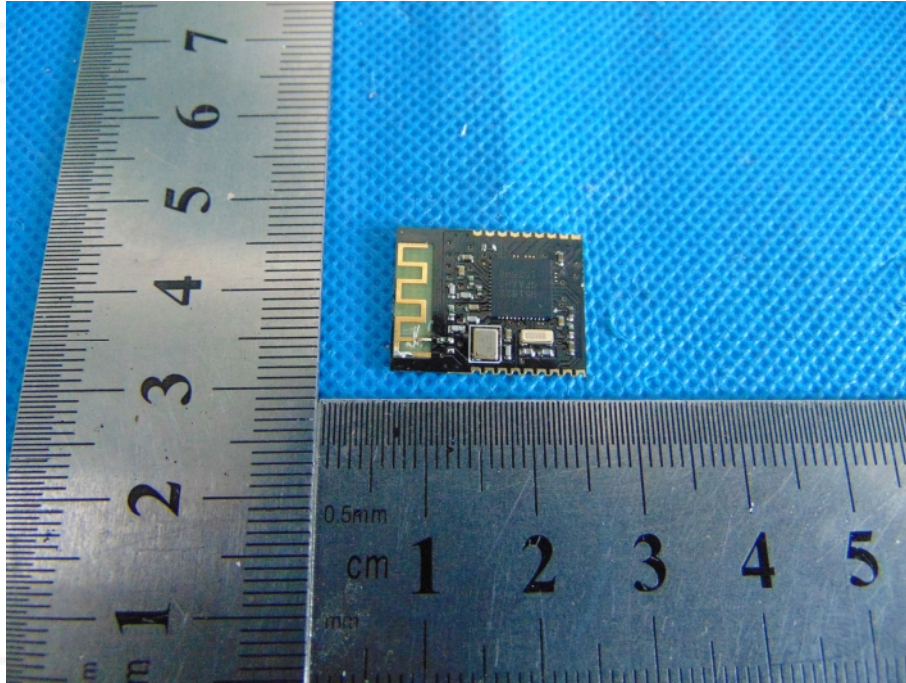

EUT Photos 2

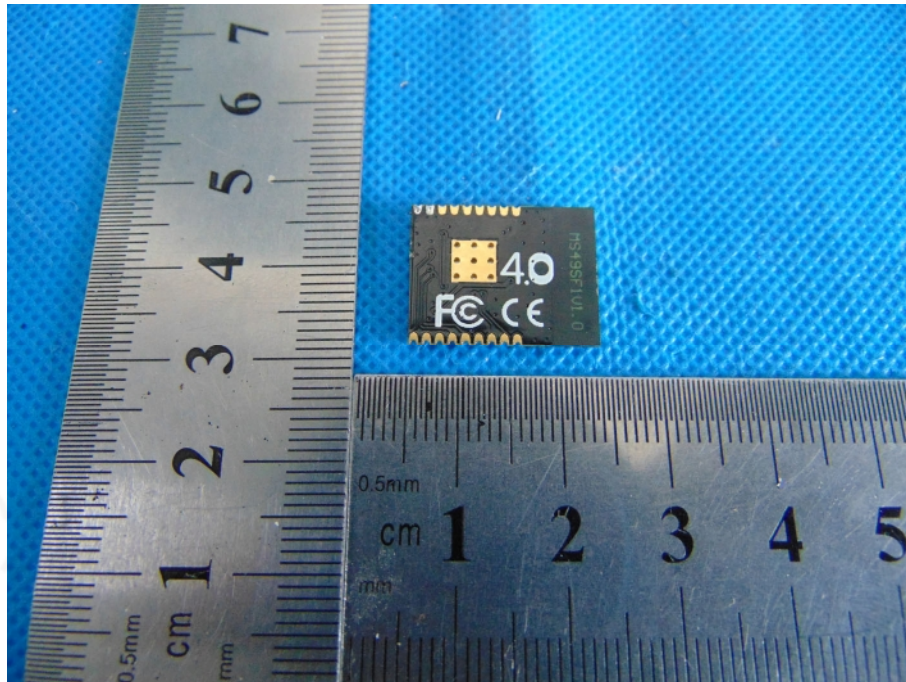

***** END OF REPORT *****